



Elementary

Day 1: Foundation of Love

Bottom Line: Jesus Chooses to Love Me

Bible Verse: I know that God started a good work in me and He will complete it. Philippians 1:6

Bonus Verse: As the Father has loved me, I have also loved you. Remain in my love. John 15:9

Bible Story: Jesus Chose Matthew (Matthew 9:9-13)

Matthew was a tax collector and often sat at a booth where people came to pay their taxes. Many people did not like tax collectors because they often took more money than they were supposed to. They kept the extra for themselves! One day Jesus walked by and saw Matthew sitting at the tollbooth. Jesus said to Matthew, "Follow Me." Matthew got up immediately, leaving everything behind, and followed Jesus.

Matthew hosted a grand banquet at his house. Jesus and His disciples came to the banquet. Many tax collectors and other sinners were also at the banquet eating with Jesus and the disciples. When the Pharisees (teachers of the law) saw this, they began to complain to the disciples. They asked why Jesus would eat and drink with tax collectors and sinners. Jesus overheard the Pharisees talking to His disciples. He said to them, "It is not those who are well who need a doctor, but those who are sick. For I didn't come to call the righteous, but sinners." Jesus was not interested in how good a person was or how bad.

Jesus wanted people to listen and follow Him.

Fun Activity: Taxing Coin Drop

This tax paying game will remind us of the tax collector from our story, his name was Matthew.

You will need 4 coins, and a cup. Standing up, take the coins one at a time and hold them at the tip of your nose and drop them in the cup at your feet. The goal is to try to get all four coins in the cup in 30 seconds. Take as many try's as you need to get all four coins in the cup! You got this, good luck!

Craft:

Grab a piece of paper and crayons or markers and create your own money pouch to remind us that Matthew was a tax collector before Jesus chose him to be a disciple!



JESUS CALLS MATTHEW

Matthew 9:9-13

Cross out all of the D, F, B, S, H, I and G's to see what Matthew's job was before he followed Jesus. Write your answer on the lines.

S	D	H	I	T	F	H	S	I	D
B	G	F	A	I	D	G	H	B	F
X	H	B	F	D	B	S	H	S	D
G	H	S	B	F	C	I	G	B	S
S	H	O	I	H	G	B	F	B	S
L	B	I	H	G	D	F	S	L	B
S	H	I	G	D	F	B	S	H	I
S	G	S	S	H	I	B	G	E	F
H	I	G	B	S	G	S	D	F	C
F	B	S	G	H	I	D	B	S	F
G	H	I	G	B	F	S	T	B	S
F	H	I	G	B	S	B	O	F	S
B	D	H	B	S	G	S	D	F	R

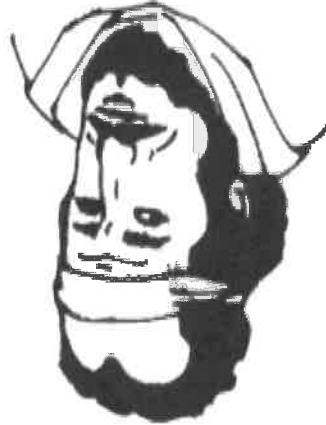

Matthew was one of Jesus' disciples. Before Jesus called him to be a follower, Matthew had a very unpopular position.

CONCRETE & CRANES
Philippines 1:6



JESUS!
OUR STRONG
FOUNDATION!

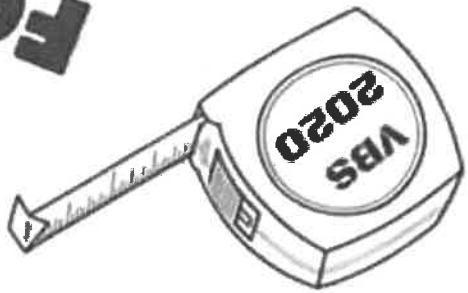

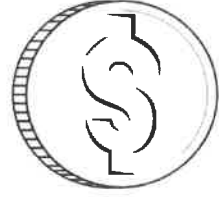
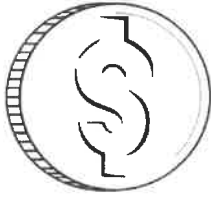
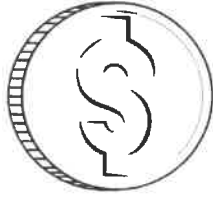
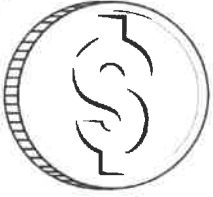

Matthew 9:13

“sinners.”

the righteous but the

“For I didn’t come to call

The calling of Matthew

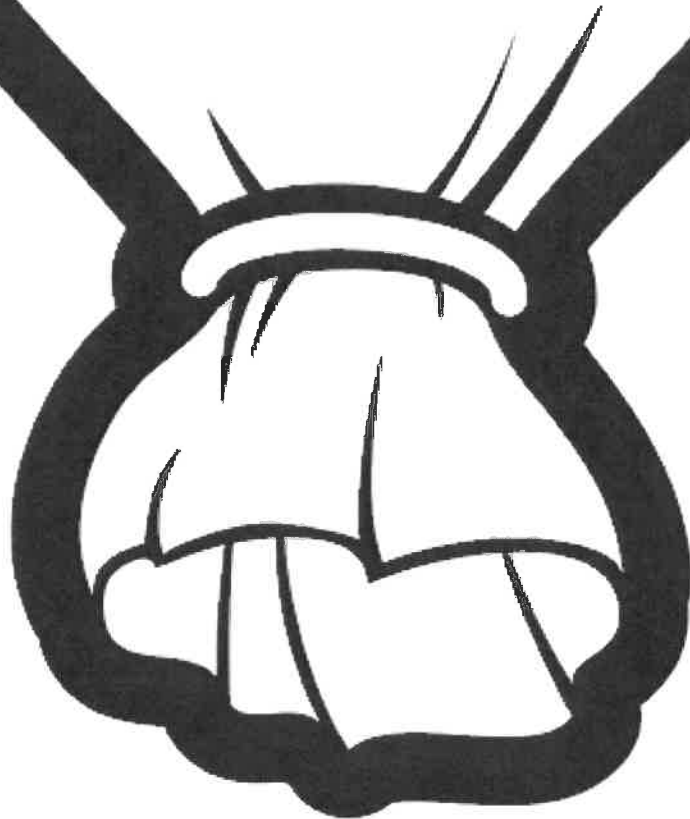

Elementary

Day 2: Foundation of Forgiveness

Bottom Line: Jesus loves me regardless of my sin.

Bible Verse: I know that God started a good work in me and He will complete it. Philippians 1:6

Bonus Verse: But God proves his own love for us in that while we were still sinners, Christ died for us. Romans 5:8

Bible Story: Paul's Redemption Acts 26:1-29

The Apostle Paul wasn't known for holding his tongue. Instead, Paul spoke boldly and without fear because he knew he spoke truth. Paul was chosen by God to bring the good news about Jesus to the Gentiles. He was arrested and later taken to King Agrippa to tell his story. Paul told how he used to persecute believers. But one day, on the road to Damascus, he saw a bright light and heard a voice speaking to him. The voice was Jesus. Paul obeyed Jesus' command and told people everywhere that Jesus is the Messiah.

Fun Activity: Wrecking Ball Water Pinata

****Parental supervision advised.****

Fill up balloons with water and hang them somewhere outside. Using inflatable tools, Plastic tools, or a stick; strike the balloons until it bursts. Have fun!
*Use a blindfold to make it more challenging! *

Craft:

Grab the supplies that are labeled day 2 and color your own megaphone to remind us how Paul spoke boldly and without fear about Jesus.



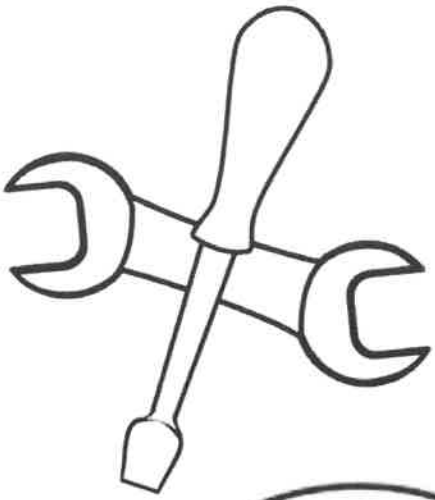

CONCRETES & CRANES

Philippians 1:6

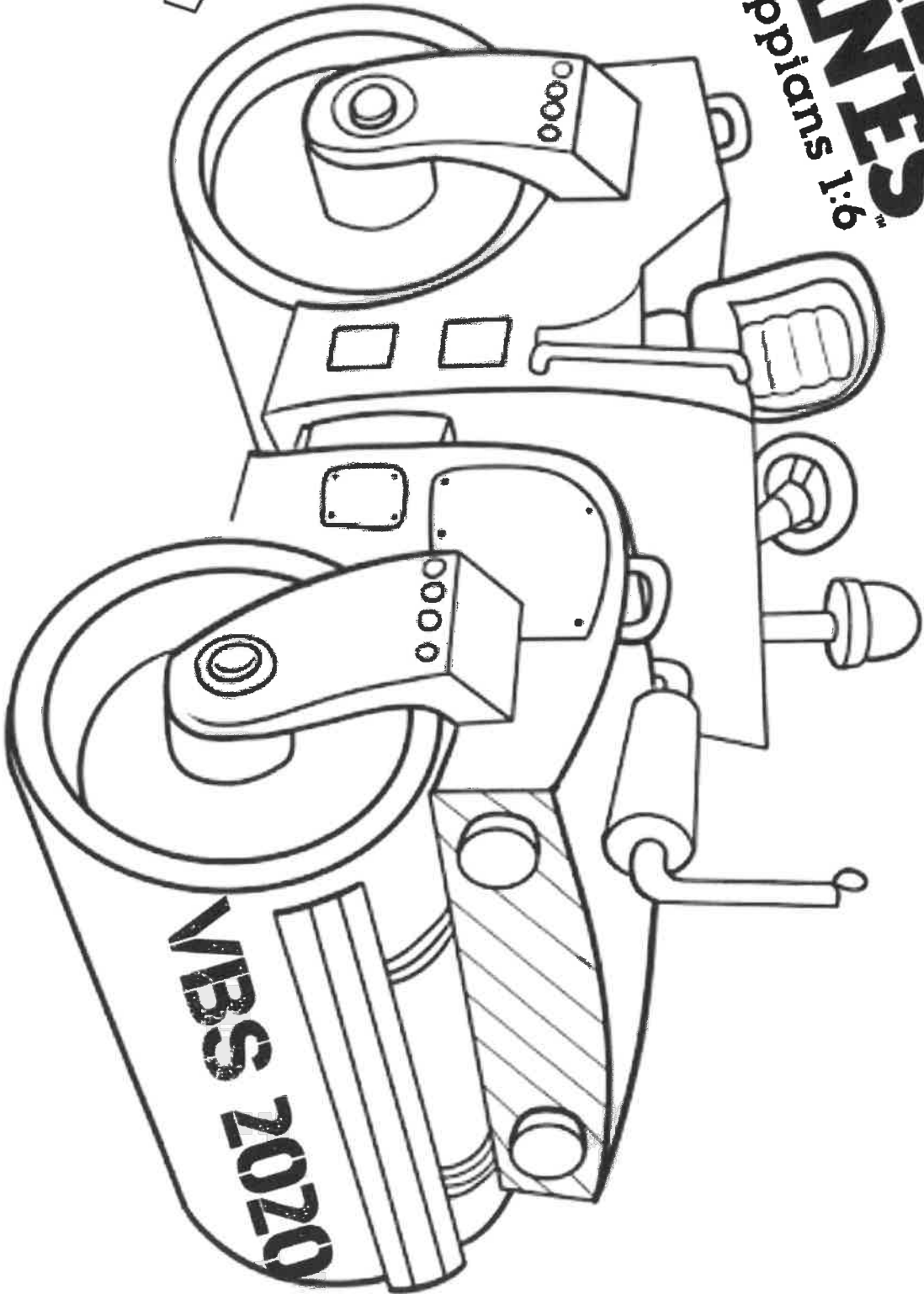

Romans 5:8

O K J N C K S S H O W S G K J W I
N Z Q F K E F S M T I A S Z P T K
D H B E X S U E V M G P X P A I C
U Y Y G I T N D W M Y Y G Q N R U
W D E I D B V J O I K X O N S U A
L F F S S P E P E V O L Z K I O L
A O V A G O F I G H S F U P H Y M
R T M N D S D T P L E Z B A W F L
S X G O S N V R Y Y C F I O G I M
B O A I D R Y J T Z M Z C E Z X Y
D Y T C E T I H W S I N N E R S K
S G T P Q H J T G X T M I L E K J
T S I R H C H O H X U A L Z W A K
R Y R E M G O D D A X P S N G U C
I G H R L C B U T G T J U P I W Q
G P N E H Z E M T Q B X P S S V S
K T R W F Q H L S T I L T H U S T

Us For Died Christ
Sinners Still Were We
While That In Love
His Shows God But

BOLDLY

And now, Lord,
consider their
threats, and grant
that their servants
may speak your
word with all boldness.
Acts 4:29

SPEAK



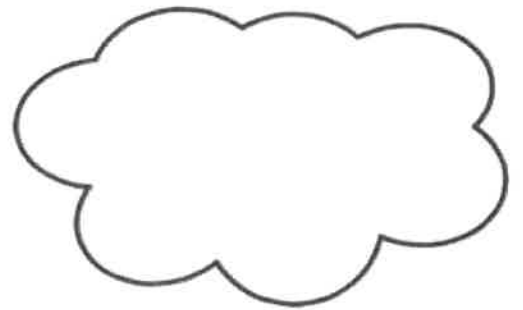
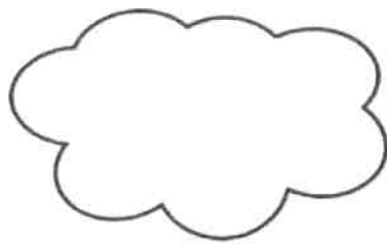
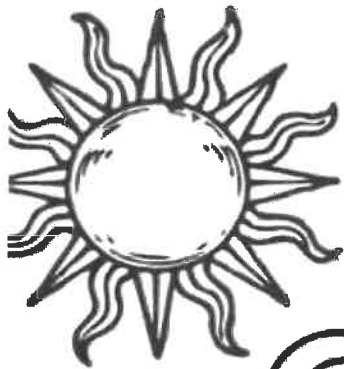
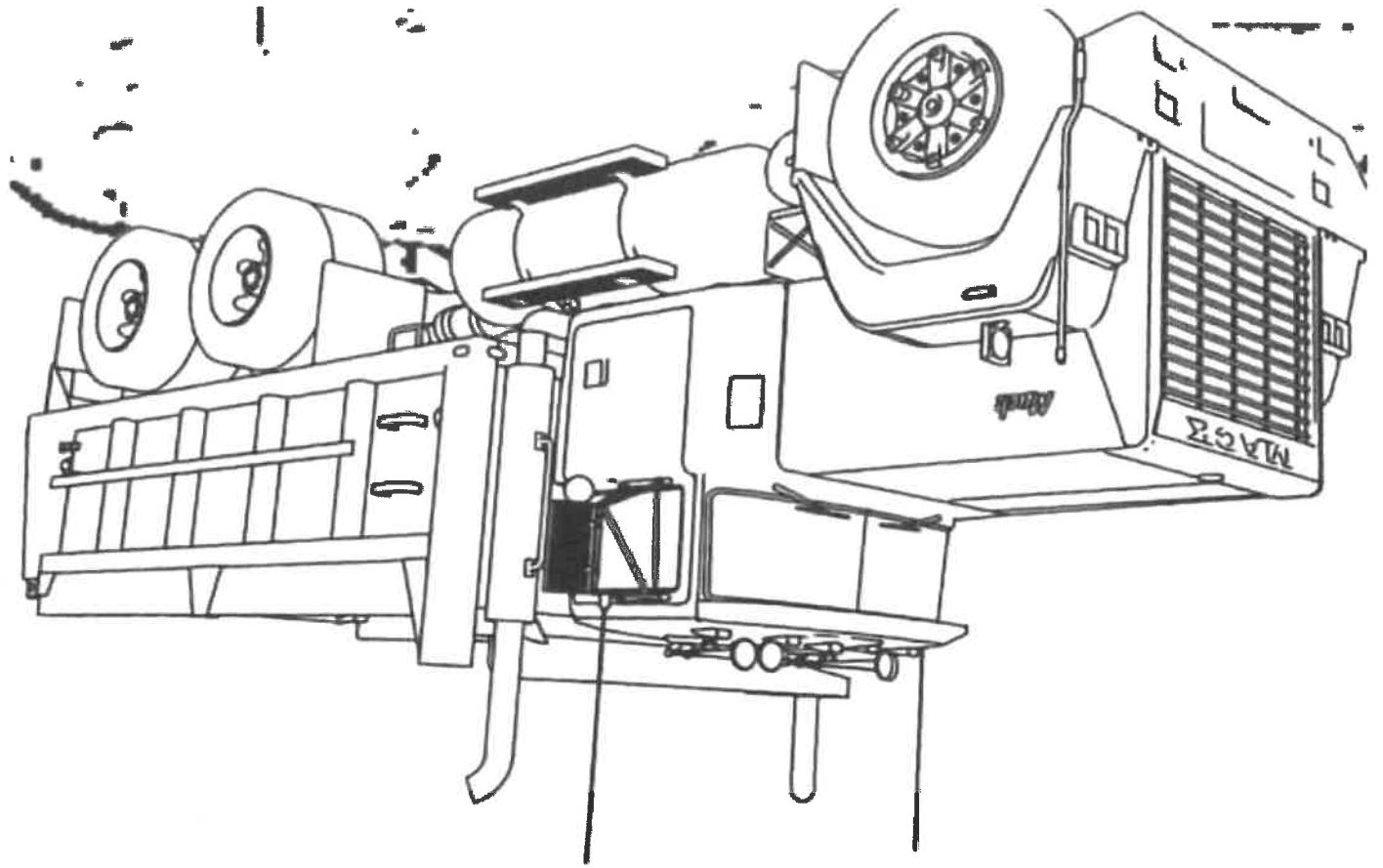

BE STRONG IN
THE LORD

Garden of Gethsemane Maze

John 18:1-When Jesus had spoken these words, he went forth with his disciples over the brook Cedron, where was a garden, into the which he entered, and his disciples.

Matthew 26:36 Then cometh Jesus with them unto a place called Gethsemane, and saith unto the disciples, Sit ye here, while I go and pray yonder.

Get Jesus to the Garden of Gethsemane.

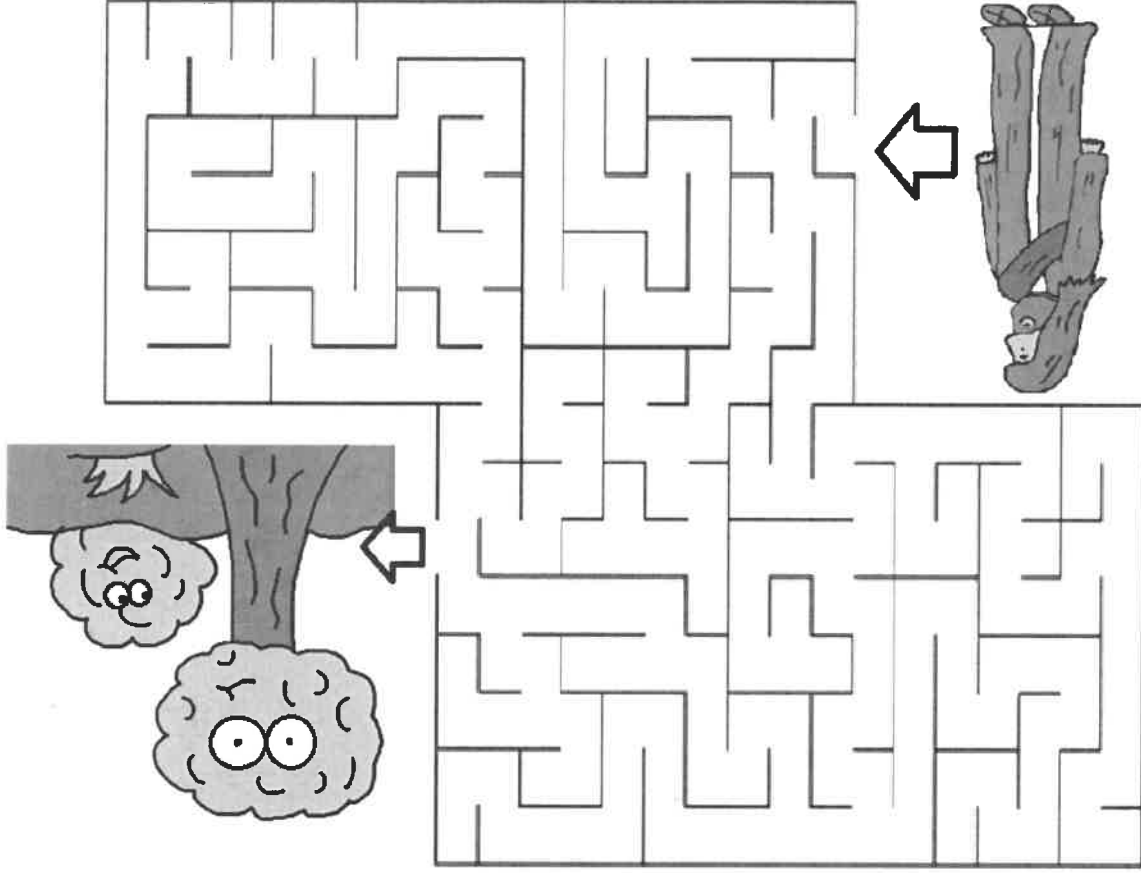

Elementary

Day 4: Foundation of Promise

Bottom Line: Jesus will always love me.

Bible Verse: I know that God started a good work in me and He will complete it. Philippians 1:6

Bonus Verse: And remember, I am with you always, to the end of the age. Matthew 28:20b

Bible Story: Jesus' Resurrection and Promise (Matthew 28:1-10,16-20)

On the Sunday after Jesus' death, Mary Magdalene and Mary the mother of James went to the tomb. When they arrived, they saw that the stone had been rolled away and an angel was sitting on it. The angel told the women that Jesus had risen. He instructed them to go tell the disciples to meet Jesus in Galilee. Later the disciples traveled to Galilee, where they saw Jesus. The disciples received instructions from Jesus and the promise that He would be with them always!

Fun Activity: Cup Stack

Using plastic stackable cups, try stacking the cups in a pyramid as fast as you can. Can you do them in under 10 seconds?

To make it more challenging, write the phrases of the verse on the cups and try stacking them up in verse order!

Craft:

Grab the supplies that are labeled day 4 and create your own thumb print magnet to help us remember to follow God's path and to help build the Kingdom!



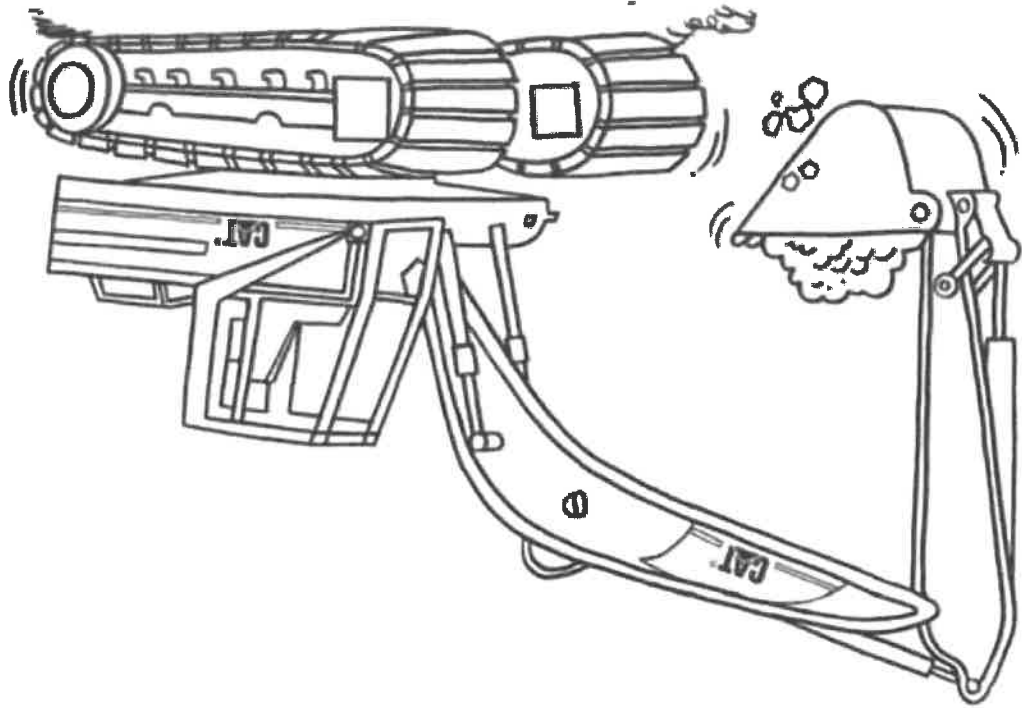

PAVES THE WAY

JESUS

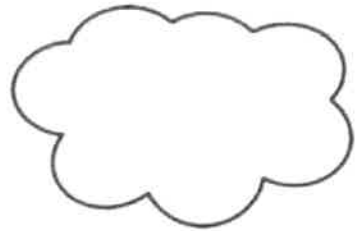

28:20

Tracing practice boxes for the number 28:20

Tracing practice boxes for the first line of the verse

Tracing practice boxes for the second line of the verse

Tracing practice boxes for the third line of the verse

Tracing practice boxes for the fourth line of the verse

Write the Bible verse in the boxes below.

Bible Verse Box Writing

Matthew 28:20

“and teaching them to obey everything I have commanded you”

Elementary

Day 5: Foundation of Life

Bottom Line: Jesus' love is the foundation for the rest of my life.

Bible Verse: I know that God started a good work in me and He will complete it. Philippians 1:6

Bonus Verse: Wise and Foolish Builders (Matthew 7:24-29)

Bible Story: Wise and Foolish Builders (Matthew 7:24-29)

Jesus told a parable about two builders. He said that everyone who heard His words and acted on them would be like the wise man who built his house on the rock. The house had a strong foundation and would stand against the wind and the rain. However, those who did not listen would be like the foolish builder who built his house on the sand. Once the wind and rains came, the house collapsed. If people listen and obey Jesus, they will have a strong foundation for whatever happens in their lives.

Fun Activity: Obstacle course

Set up an outside obstacle course with hula hoops, a kiddie pool, boxes and even other creative objects. Try to get through the course as fast as you can!

Craft:

Grab the supplies that are labeled day 5 and create your own sign to remind us that there is no job too big for God!



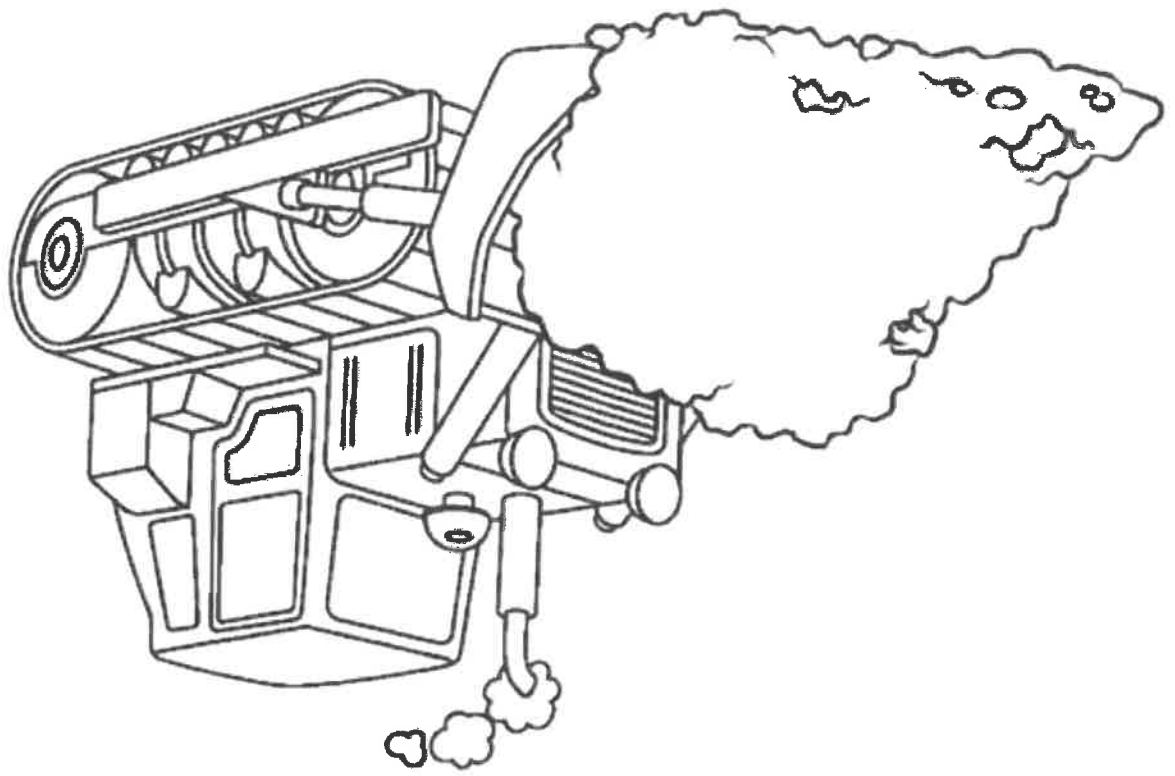

JESUS
OUR STRONG
FOUNDATION

Wise or Foolish

"Therefore everyone who hears these words of mine and puts them into practice is like a wise man who built his house on the rock. Matthew 7:24 (NVI)

Based on Matthew 7:24-27

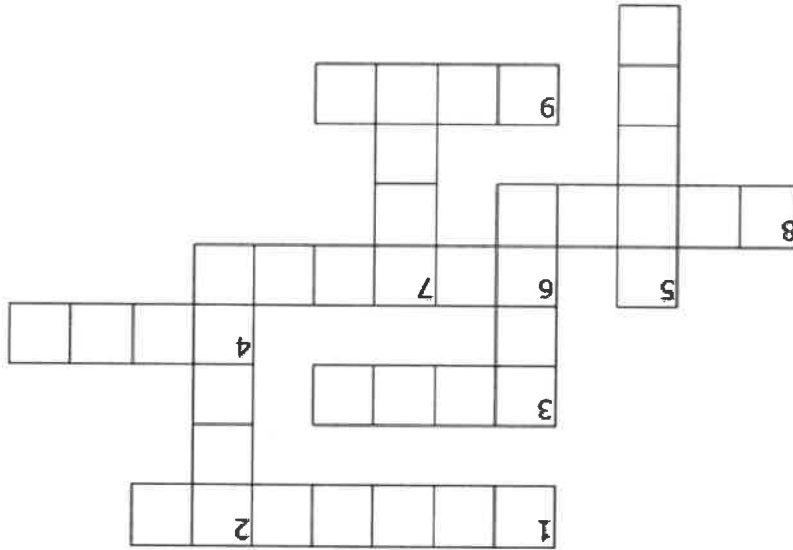

ACROSS

1. Lacking good sense
3. The natural movement of air
4. A large stone
6. A small river
8. A building where a family lives
9. Loose soil which is found on beaches

DOWN

2. A sudden or violent condition in nature
3. Someone who exercises good judgment in his daily life is
5. To make or form something such as a house
7. Water that falls from the sky

HOUSE	FOOLISH	BUILD	RAIN	SAND	STORM	WIND	ROCK
WISE	STREAM						

WORD

GOD'S

BUILD ON

